

NEON CLASSIC

WHITE | SILICONE

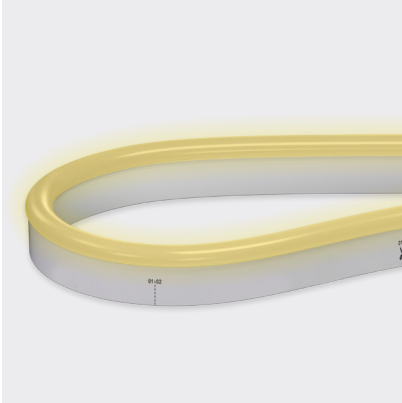

MARTINI GLASS OUTLINE IN NEON CLASSIC WHITE

Neon is a broad range of silicone encapsulated LED ribbons with a variety of light emissions and casings that closely reference glass neon tube.

Neon Classic is a perfect replacement for traditional glass neon tube with dimensions of W16.5 x H29mm (W11.5mm at the base).

Neon is made to order, check with our team for lead times.

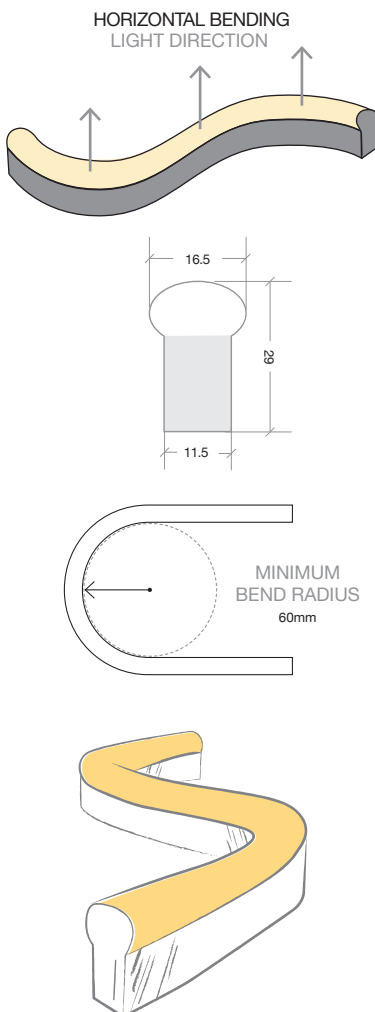

CODE	COLOUR	LUMENS
BL-LS-4580S-27	WARM WHITE 2700K +/- 110K	≥470lm/m
BL-LS-4580S-30	WARM WHITE 3000K +/- 150K	≥470lm/m
BL-LS-4580S-40	NATURAL WHITE 4000K +/- 165K	≥470lm/m
BL-LS-4580S-57	COOL WHITE 5700K +/- 335K	≥470lm/m

ELECTRICAL & OPTICAL DATA VARIANCE +/- 10%. SOLD BY THE METRE. IES FILES AVAILABLE. 2200K & 3500K AVAILABLE BY REQUEST.

POWER & TEMP	
LED WATTS	12W/m
INPUT VOLTS	24V DC Constant voltage Onboard constant current
OPERATING TEMP. (ENVIRONMENT)	-40°C ~ +55°C
MAX. RUN PER POWER FEED	15m using one feed 30m using two feeds
LIGHT & LIFE	
CRI	≥80
BEAM ANGLE	180°
LED PER METRE	72
SOURCE LIFE	50,000 hours
WARRANTY	5 years

APPLICATIONS

- Signage & cove lighting
- Architectural features
- Exterior or interior installations
- Swimming or feature pools

FEATURES

- A perfect replacement for traditional glass neon tube
- 6W/m option available for use in saunas or steam rooms

PHYSICAL PARAMETERS & CONTROL	
MINIMUM BEND RADIUS	60mm
BEND DIRECTION	Horizontal bending
DIMENSIONS	W16.5 x H29mm (W11.5mm at the base)
INGRESS PROTECTION	IP67 or IP68 Protection established by use of connectors. Dimensions of connectors shown on installation guide
CUTTING LENGTH	83.3mm
HOUSING	UV & flame resistant white silicone with opal diffuser
MOUNTING	Profile / clips available SEE PAGE 3.
CONTROL	Dimmable by PWM signal

**DON'T SEE THE OPTION FOR YOU?
LET US KNOW WHAT YOU ARE LOOKING FOR AND WE'LL SEE WHAT WE CAN DO!**

NEON CLASSIC | WHITE | CONNECTIONS

Neon products are IP rated based on the fitted connections (power feed / end caps).

Bright Light recommend using Slimline injection moulding for the best result, a clean finish and IP68 rating. These are fitted at factory during the production process and can not be altered once produced - **ensure all lengths are double-checked before ordering.**

If on-site cutting is required (due to lengths being unknown in advance or site design alterations), Snap connector fittings can be used instead. Snap Connectors can be fitted on-site and offer an IP67 rating (provided all installation instructions are followed correctly).

Power feed connectors are priced & supplied with 1metre cable as standard. Please specific at time of quoting if alternate lengths are required.

SLIMLINE INJECTION MOULDING CONNECTIONS | IP68

RECOMMENDED



REQUIRES FITTING AT FACTORY.
EXACT LENGTH REQUIRED BEFORE PRODUCTION

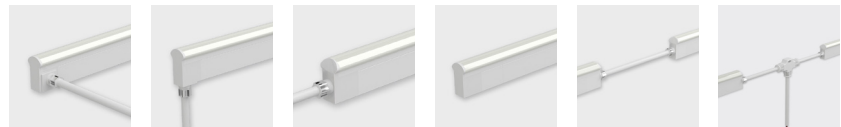

SIDE FEED BOTTOM FEED TOP END FEED END CAP 300MM FLEXIBLE CONNECTOR T FEED

SNAP CONNECTIONS | IP67

ON-SITE FITTING



FITTING ON-SITE - WHERE LENGTHS ARE UNKNOWN IN ADVANCE.
MUST BE FITTED CORRECTLY FOR IP RATING



TOP END FEED END CAP 300MM FLEXIBLE CONNECTOR

01 02 01 02

WHITE / DIM TO WARM

BL-LS-4514 BL-LS-4515 BL-LS-4526 BL-LS-4527 BL-LS-4516

NEON CLASSIC | MOUNTING ACCESSORIES

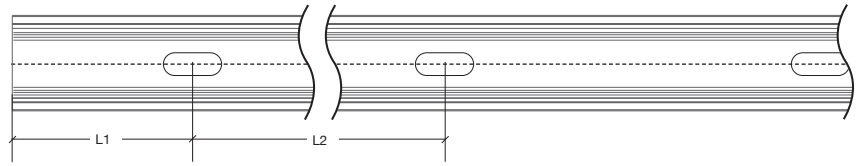

CODE	ACCESSORY	L1	L2	HOLE DIMENSIONS	HOLE NUMBER
BL-LS-4082	SERRATED ALUMINIUM CLIP 20MM	10mm	-	4 × 10mm	1
BL-LS-4080	SERRATED ALUMINIUM PROFILE 1 METRE	100mm	200mm	4 × 10mm	5
BL-LS-4081	SERRATED ALUMINIUM PROFILE 2 METRES	100mm	200mm	4 × 10mm	10
BL-LS-4083	BENDABLE SERRATED ALUMINIUM PROFILE 1000MM	116.5mm	98.8mm	Ø4.2mm	10
BL-LS-4084	THICKENED PLASTIC CLIP 35MM	17.5mm	-	4.5 × 8mm	1
BL-LS-4085	THICKENED PLASTIC PROFILE 1 METRE	100mm	200mm	4.5 × 8mm	5
BL-LS-4086	THICKENED PLASTIC PROFILE 2 METRE	100mm	200mm	4.5 × 8mm	10

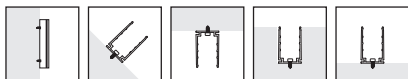
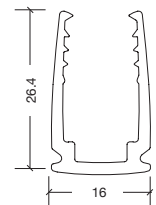
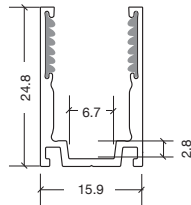
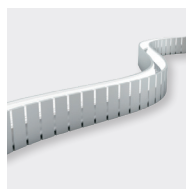
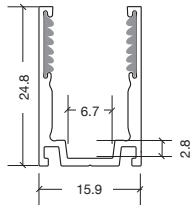

SERRATED ALUMINIUM
PROFILE 2M & MOUNTING CLIP

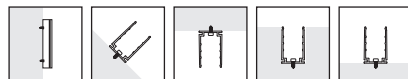

BENDABLE SERRATED
ALUMINIUM PROFILE 1M

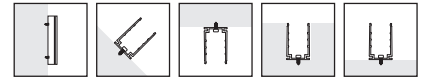

THICKENED PLASTIC
PROFILE & CLIP