

NEON MICRO ARC

ELECTRICAL & PHYSICAL INSTALLATION GUIDE

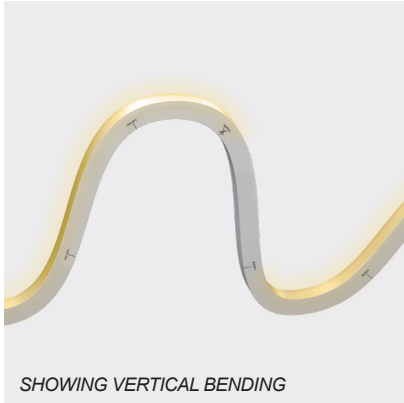

Neon is a broad range of silicone encapsulated LED ribbons with a variety of light emissions and casings that closely reference glass neon tube.

Neon Micro Arc is a square W10 × H10mm model available in either vertical or horizontal bending. Perfect for cove lighting, or architectural features in exterior and interior applications.

Neon is made to order, check with our team for lead times.

SUPPORTING NEON

Do not allow Neon to bend, twist or hang down as the weight of the light can damage the PCB. When working with a length of Neon greater than 2m long, **ensure you have at least two installers.**

FEATURES

- Neon Micro Arc comes in two versions: vertical bending & horizontal bending
- UV & flame resistant



BENDING PARAMETERS

VERTICAL BENDING

LIGHT DIRECTION
VERTICAL BENDING

✓ **VERTICAL BENDING NEON MICRO ARC CAN BE CURVED AS SHOWN BELOW**

LIGHT SURFACE

✗ **DO NOT TWIST THE LIGHT OR BEND AGAINST THE LIGHT SURFACE**

HORIZONTAL BENDING

HORIZONTAL BENDING
LIGHT DIRECTION

✓ **HORIZONTAL BENDING NEON MICRO ARC CAN BE CURVED AS SHOWN BELOW**

LIGHT SURFACE

✗ **DO NOT TWIST THE LIGHT OR BEND AGAINST THE LIGHT SURFACE**

NEON MICRO ARC | SILICONE | ELECTRICAL AND PHYSICAL INSTALLATION GUIDE

WIRING GUIDE

TO AVOID SIGNAL FADING, ENSURE THE OVERALL CABLE LENGTH IS WITHIN THE MAXIMUM SIGNAL TRANSMISSION DISTANCE ACCORDING TO THE SPECIFICATION OF CONTROLLER/DECODER

SINGLE END FEED

STANDARD CONTROL

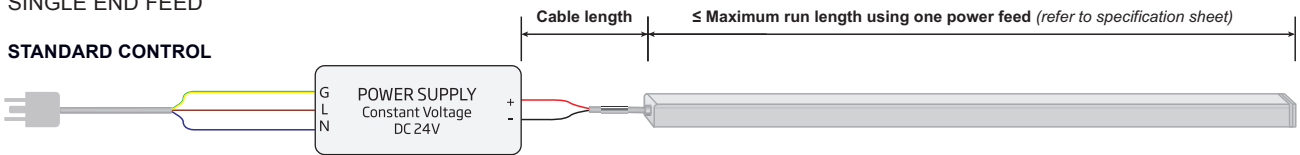

OPTIONAL DIMMER

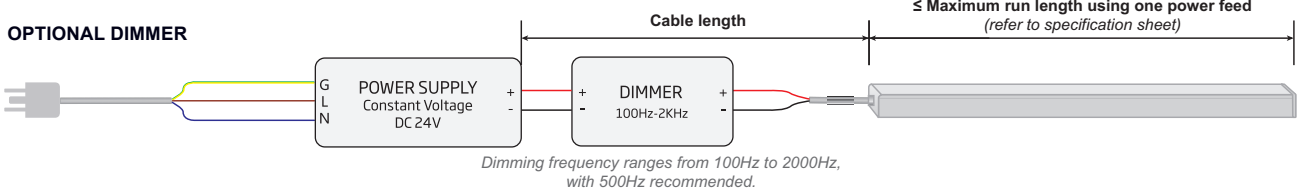

DOUBLE END FEED
STANDARD CONTROL

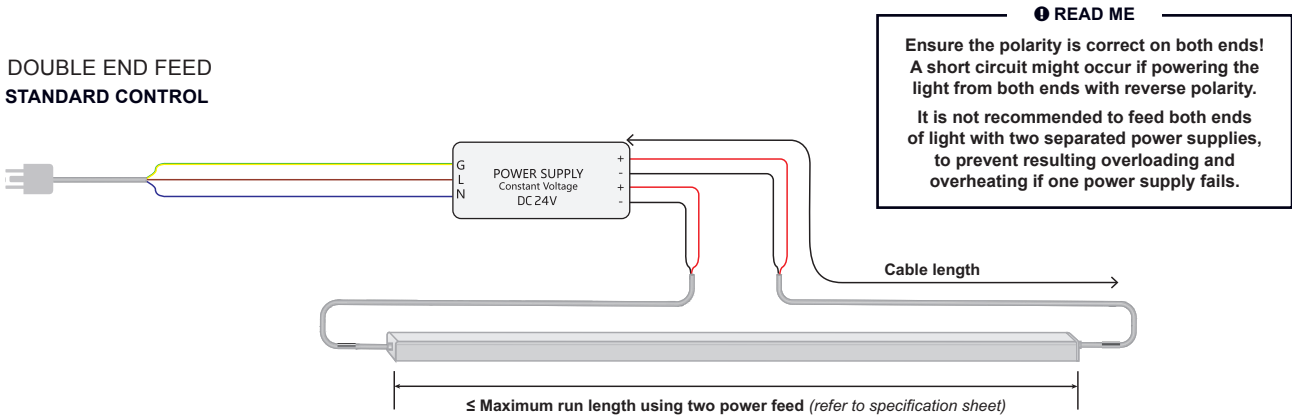

OPTIONAL DIMMER

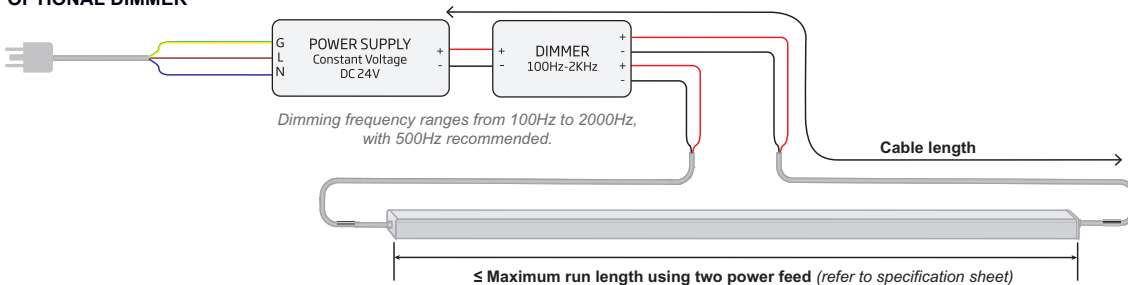

NEON MICRO ARC | SILICONE | ELECTRICAL AND PHYSICAL INSTALLATION GUIDE

CABLE LENGTH *(The total length of electrical cable between power output end and light input end, including any cables for interconnection)*

Refer to the chart where additional cable is required to access power on-site.

SINGLE END POWER FEED

The chart shows the maximum cable lengths for different wire gauges for single power feed installation to avoid voltage drop.

DOUBLE END POWER FEED

For a double power feed installation, look up half the light length for the cable length per feed (each side).

ie. For a 10metre light length you would look up a 5m light length on the chart (as each feed powers half the light).

Aim to position power supply in the middle of a single light (or multiple lights in daisy chain) to keep the same cable length for both ends.

LIGHT LENGTH (METRES)	MAX CABLE LENGTH SILICONE (METRES)				
	0.32mm ² 22AWG	0.52mm ² 20AWG	0.81mm ² 18AWG	1.32mm ² 16AWG	2.07mm ² 14AWG
1	114.8	186.6	290.6	473.6	742.7
2	57.4	93.3	145.3	236.8	371.4
3	36.3	59.0	92.0	149.9	235.0
4	27.5	44.7	69.6	113.5	177.9
5	19.8	32.2	50.1	81.7	128.1
6	17.1	27.7	43.2	70.4	110.4
7	14.4	23.5	36.5	59.5	93.4
8	11.7	19.0	29.6	48.2	75.7
9	9.7	15.8	24.6	40.1	62.9
10	8.6	13.9	21.7	35.4	55.5
11	6.8	11.0	17.1	27.9	43.7
12	6.0	9.7	15.1	24.7	38.7
13	4.9	7.9	12.3	20.1	31.5
14	4.2	6.8	10.5	17.2	27.0
15	3.2	5.2	8.1	13.2	20.7

The above cable lengths are calculated based on 10% allowable voltage drop maximum.

- LED Neon must always be used in conjunction with a certified Bright Light 24V DC power supply.
- Check the polarity of the connector before inserting the front connector and switching on the mains power.
- To minimise voltage drop and ensure consistent light output, position the power supply near to the power feed end of the LED Neon, and keep the line as short as possible
- Ensure your maximum run per power feed adheres to the guidelines; see specification sheet.
- Ensure to add 20% buffer when selecting a power supply
- Before making any cuts, installation, maintenance, or connection, be sure the mains power is disconnected.
- If essential; cut and connect LED Neon correctly. Any incorrect operation can cause damage.
- All connector joints must be connected correctly to achieve connector IP rating.

NEON MICRO ARC | SILICONE | ELECTRICAL AND PHYSICAL INSTALLATION GUIDE

BENDING PARAMETERS

- LED Neon can be bent up to the defined “minimum bend radius” (50mm for Neon Micro Arc)

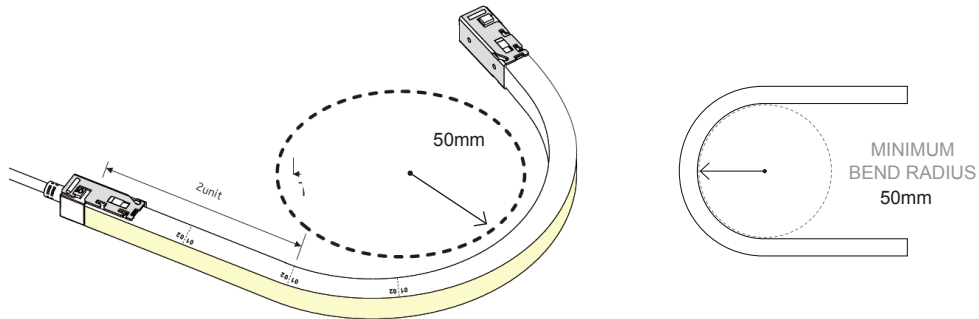

- Avoid bending LED Neon within the first unit (units are clearly marked with dashed lines on the sides of the product)

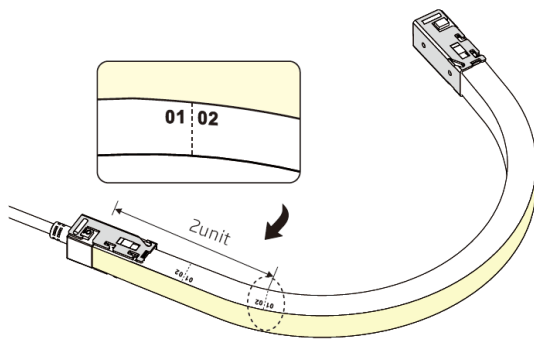

NEON MICRO ARC | SILICONE | ELECTRICAL AND PHYSICAL INSTALLATION GUIDE

PROFILE / CLIP INSTALLATION REQUIREMENTS

REFER TO **SPECIFICATION SHEETS** FOR PROFILE DETAILS & DIMENSIONS

PROFILE MOUNTING

For all mounting profiles/clips, ensure screw head is flush or lower than the profile groove and is aligned into mounting surface straight.

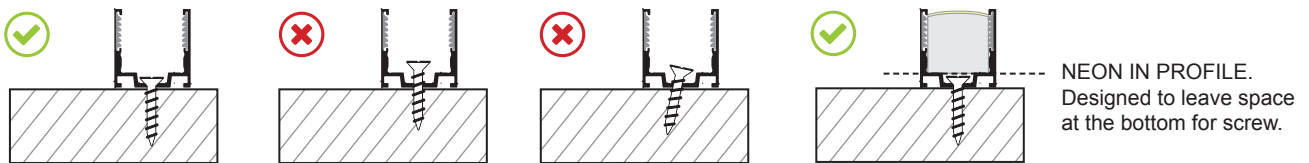

QUANTITY OF MOUNTING CLIPS REQUIRED



The exact quantity will depend on shape and installation.

MIN. 5 PER METRE. If an installation is vertical or holding Neon upside down, then 8-10 per metre.

HORIZONTAL BENDABLE SERRATED ALUMINIUM PROFILE



Use holes to screw bendable profile to create the desired horizontal curve shape. 1metre length will have 10 holes.

NEON MICRO ARC | SILICONE | ELECTRICAL AND PHYSICAL INSTALLATION GUIDE

PROFILE INSTALLATION REQUIREMENTS

- Keep 10–20mm space between the end of the profile and the connector or end cap. This allows for contraction/expansion of the LED Neon and/or movement of the mounting profile with risking damage to the connector /end cap.

TOP END FEED

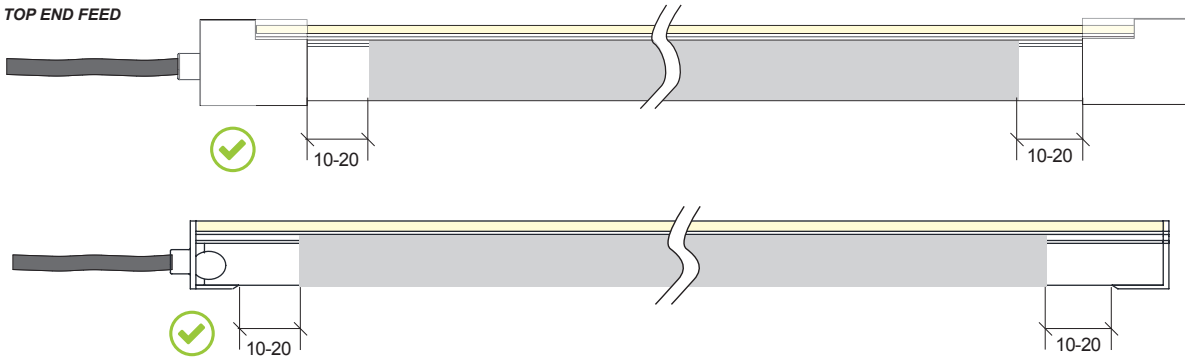

BOTTOM FEED / SIDE FEED

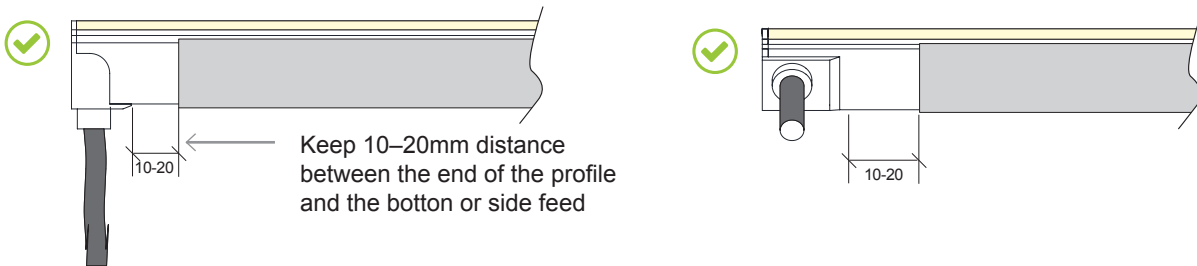

- Avoid placing mechanical stress on the front connector cable

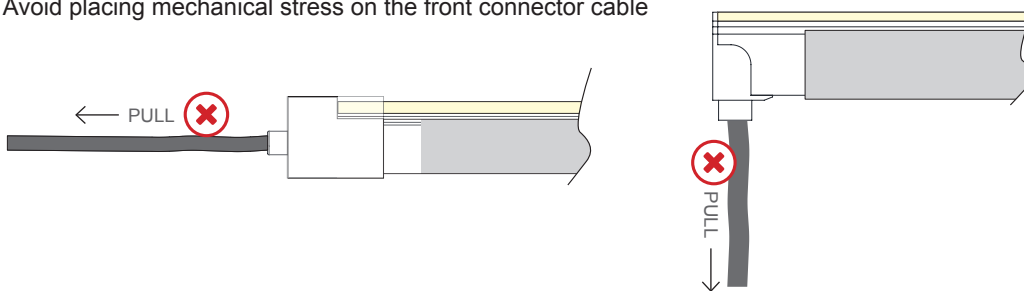

- Do not curl or bend the front connector cable with excessive force.
- Try to keep at least 60mm of cable straight before any curve (top / bottom / side feed)

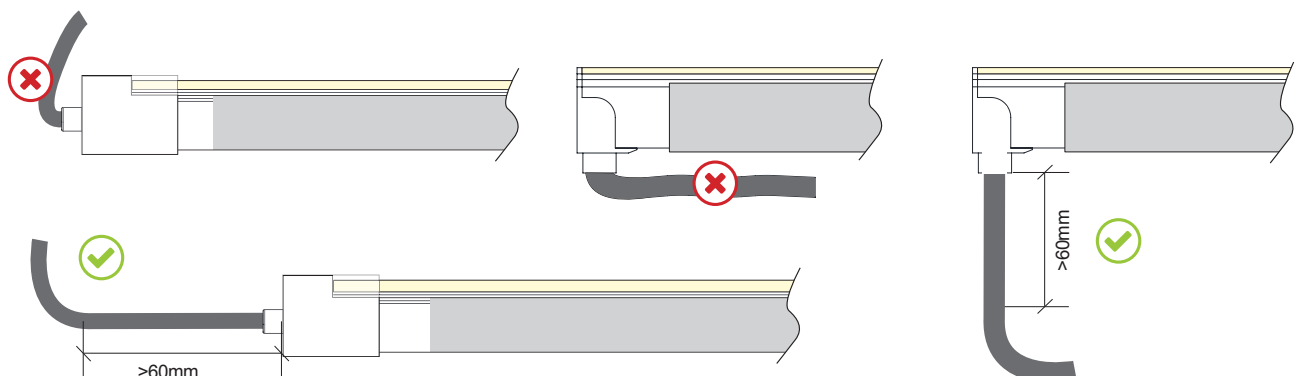

NEON MICRO ARC | SILICONE | ELECTRICAL AND PHYSICAL INSTALLATION GUIDE

PROFILE INSTALLATION REQUIREMENTS

- The bend angle should be less than 15 degrees when installing into the profile (for Horizontal bending model)

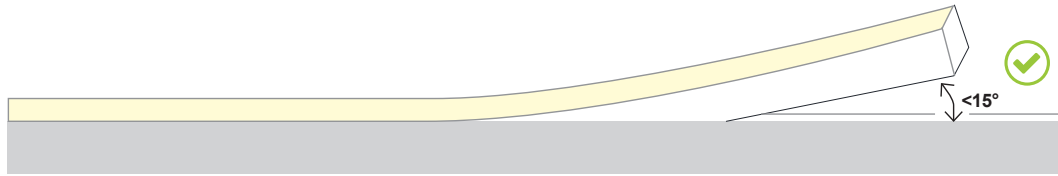

- Avoid installing the profile less than 10mm from the end mounting piece

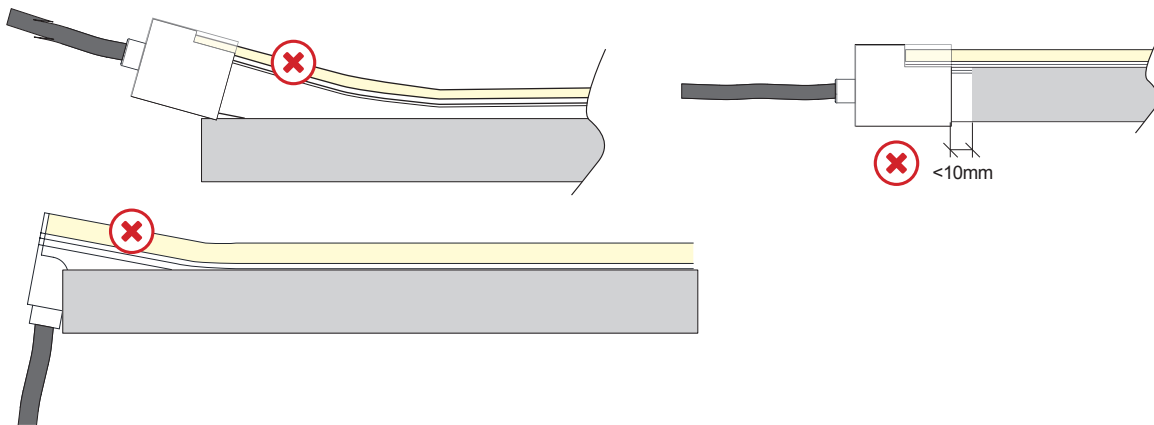

- Install the LED Neon into the profile in one direction, don't let it bow in the middle

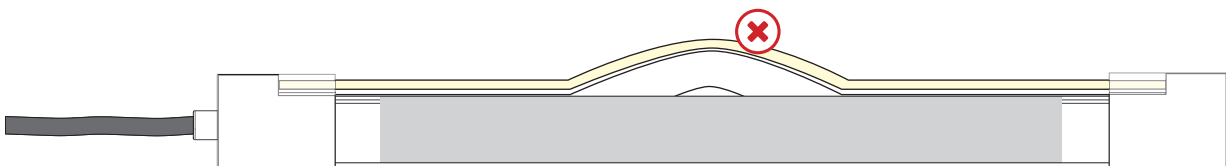

NEON MICRO ARC | SILICONE | ELECTRICAL AND PHYSICAL INSTALLATION GUIDE

ANTI-WICKING FERRULE

The **anti-wicking ferrule** is a small ring of metal fitted on Neon LED power feed cables. It is primarily for Neon installed outside or near water sources and is not required when Neon is being used indoors.

The ferrule is designed to lower the risk of water ingress into the Neon LED Light through the cable in the case of inadequate waterproofing of cable power supply connection on-site. The IP rating gives the rating of the connector type for external water/moisture. The ferrule is protecting from accidental internal moisture.

Bright Light has transitioned to a silicone-based Neon product that comes with a ferrule as standard for both IP68* injection connections and IP67 Snap Connectors, which can be fitted at the factory or on-site. (**Micro Arc is are only available in IP67*)

Previous models of PVC Neon have several connection types available, but only connections with an IP67 rating or higher for outdoor use come with a ferrule as standard.

INDOOR OR OUTDOOR APPLICATION (NOT UNDER WATER)

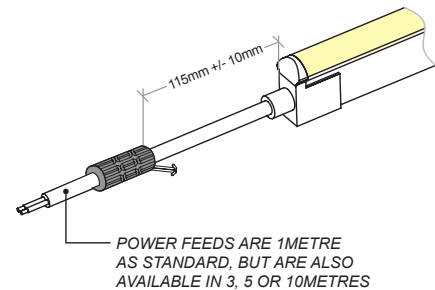

FAQ

DO I NEED A FERRULE?

Indoor applications: It's not essential, but recommended as it does provide an extra layer of protection.

Outdoor applications: It is strongly recommended and will come as standard unless requested to not be included.

If the cable & power supply connection location is suitable waterproofed to prevent any water ingress, then the ferrule is not required. However, if water ingress does occur it is not covered under warranty.

WHAT IF THE FERRULE DOESN'T FIT IN MY INSTALLATION?

Is it important to check and plan with on-site installers before ordering the product. The ferrule is larger than the cable and is an important consideration when planning installations - refer to diagrams on connection pages for dimensions.

If required, the ferrule can be left off at time of production, **however** the on-site installers/client will need to provide adequate waterproofing of cable and cable connection to the power supply to ensure there is no water ingress and any failures from this cause will not be covered by the warranty.

CAN I CUT IT OFF?

Not recommended. The ferrule is fitted 115mm from the connector (except underwater), so cutting it off doesn't leave much cable to work with.

Cutting off the ferrule will also void any warranty cover from failure due to water ingress.

UNDERWATER USE

For underwater use with IP68 injection connections, a minimum cable length of 3 metres is standard to ensure that the cable to power connection is located away from the water.

When using the anti-wicking ferrule for underwater applications, ensure that it is located above & away from water and in a waterproof location to prevent water ingress.

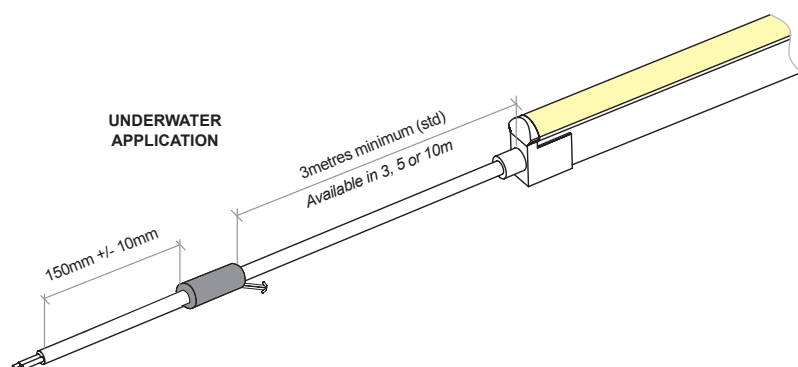

CALL US TO DISCUSS USING INJECTION
MOULDING FOR YOUR NEXT PROJECT

NEON MICRO ARC | SILICONE | INJECTION MOULDING CONNECTIONS

Bright Light recommend using Slimline injection moulding for the best result, a clean finish and IP67 rating. These are fitted at factory during the production process and can not be altered once produced - **ensure all lengths are double-checked before ordering.**

Power feed connectors are priced & supplied with 1metre cable as standard. Please specify at time of quoting if alternate lengths are required.

SLIMLINE INJECTION MOULDING CONNECTIONS | IP67



REQUIRES FITTING AT FACTORY.
LEAD TIMES APPLY
CONNECTOR TOLERANCE +/-0.5MM

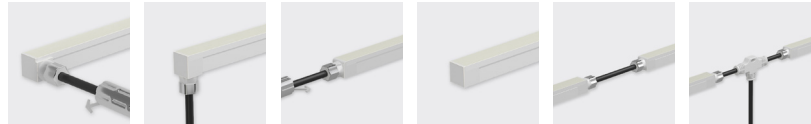

**SIDE FEED BOTTOM FEED TOP END FEED END CAP 300MM FLEX-
IBLE CONNECTOR T FEED**

WHITE - VERTICAL & HORIZONTAL BENDING



SIDE FEED

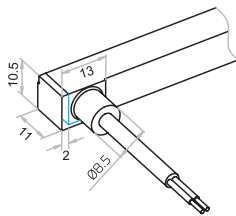

BOTTOM FEED

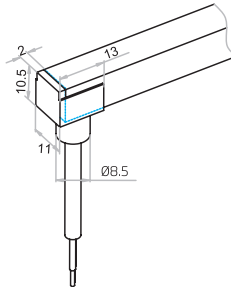

TOP END FEED

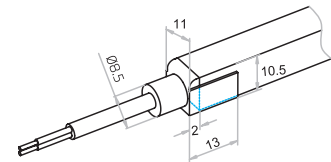

END CAP

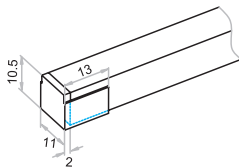

FLEXIBLE CONNECTOR

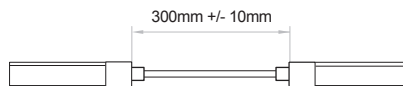

T-FEED

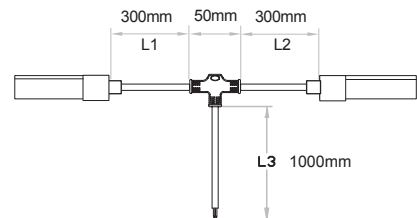

ANTI-WICKING FERRULE

(INCLUDED FOR ALL INJECTION CONNECTIONS)

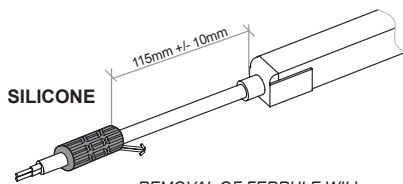
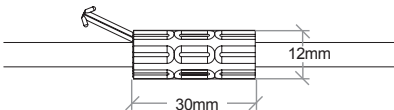

REMOVAL OF FERRULE WILL
VOID WARRANTY IF RESULTING
IN WATER INGRESS

NEON MICRO ARC | SILICONE | SWIVEL CONNECTIONS

If on-site cutting is required (due to lengths being unknown in advance or site design alterations), IP20 Swivel connector fittings are available.

Power feed connectors are supplied with 1metre cable.

SWIVEL CONNECTIONS | IP20



INSTALLATION WITH DOUBLE POWER FEED:
FEED 01 + FEED 02

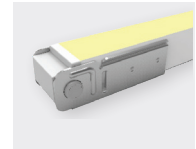
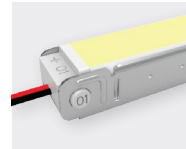

	TOP END FEED		END CAP
	01	02	
WHITE - HORIZONTAL BENDING	BL-LS-4851	BL-LS-4852	BL-LS-4854
WHITE - VERTICAL BENDING	BL-LS-4861	BL-LS-4862	BL-LS-4863

TOP END FEED

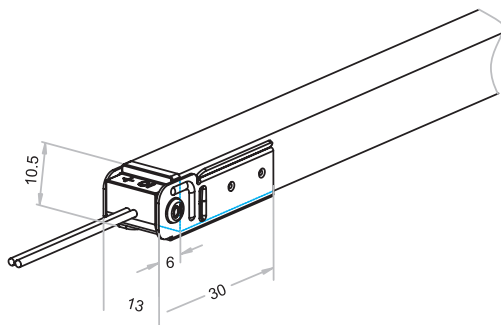

END CAP

