

NEON MICRO X | 5W/M | SINGLE COLOUR

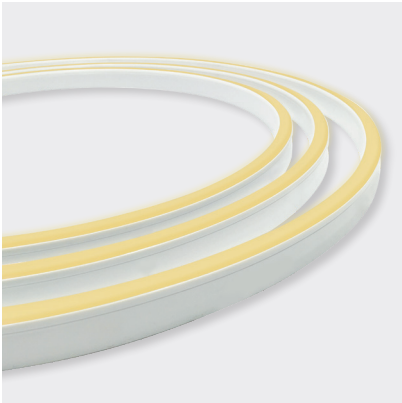

CODE: NEON-MX-5W-XX

Colour eg 27 / 30 / 40 / B

COLOUR	LUMENS
2200K +/- 145K (22)	105lm/m
2700K +/- 145K (27)	115lm/m
3000K +/- 175K (30)	155lm/m
3500K +/- 275K (35)	132lm/m
4000K +/- 275K (40)	120lm/m
4500K +/- 275K (45)	135lm/m
5000K +/- 300K (50)	140lm/m
6500K +/- 520K (65)	150lm/m
Green (G) 520–530nm	140lm/m
Blue (B) 455–465nm	17lm/m
Red (R) 620–630nm	45lm/m

ELECTRICAL & OPTICAL DATA VARIANCE +/- 10%
SOLD BY THE METRE
IES FILES AVAILABLE

APPLICATIONS

- Cove lighting, handrails, or toekicks
- Architectural features
- Exterior or interior installations
- Swimming or feature pools

FEATURES

- UV & flame resistant
- Suitable for use around salt or chlorinated water

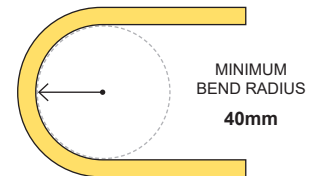
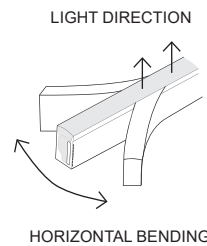
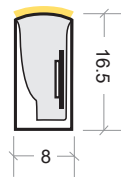
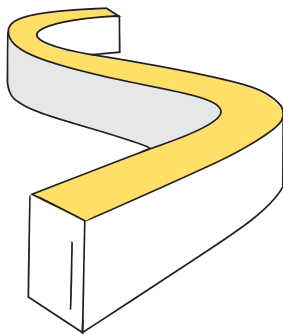

LED WATTS	5W/m
INPUT VOLTS	24V DC Constant Voltage
OPERATING TEMP.	-25°C ~ +50°C
MAX. RUN PER POWER FEED	10m using one feed 20m using two feeds

CRI	≥80
BEAM ANGLE	120°
LED TYPE	Epistar SMD LED 2835
LED QTY	70 LED/m
SOURCE LIFE	50,000 hours
WARRANTY	5 years

DIMENSIONS	W8 × H16.5mm
BEND DIRECTION	Horizontal bending
CUTTING LENGTH	100mm
MINIMUM BEND RADIUS	40mm
HOUSING	UV & flame resistant white PVC
INGRESS PROTECTION	IP67 Snap Connector or IP68 Injection Moulding <i>Protection established by use of connection type</i>
CONTROL	Dimmable by PWM signal
MOUNTING	Profile and clips available

NEON MICRO X | 5W/M | SINGLE COLOUR | CONNECTION DIAGRAMS

FG (Green)
ACL (Brown)
ACN (Blue)

L N

① Regular Connection

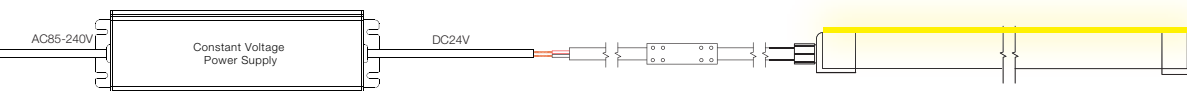

② PWM Dimming

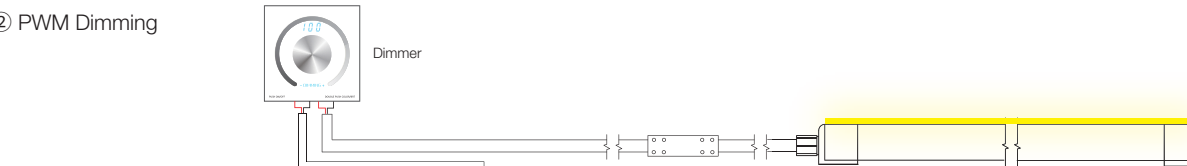

③ DMX Dimming

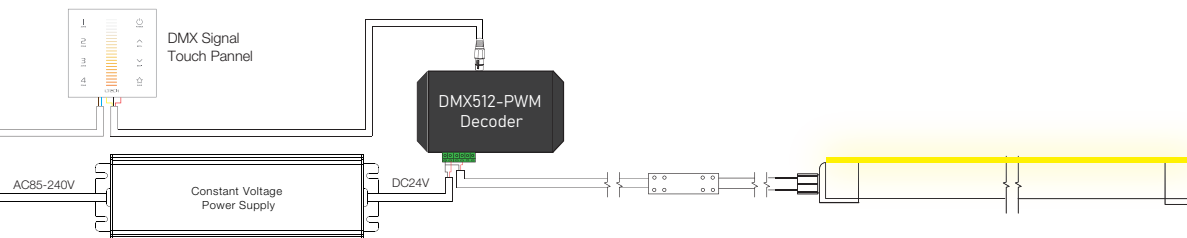

④ 0-10V Dimming

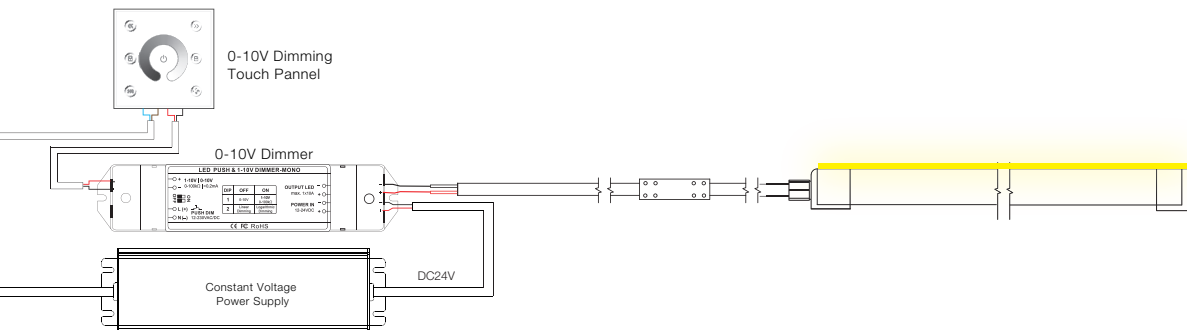

⑤ Dali Dimming

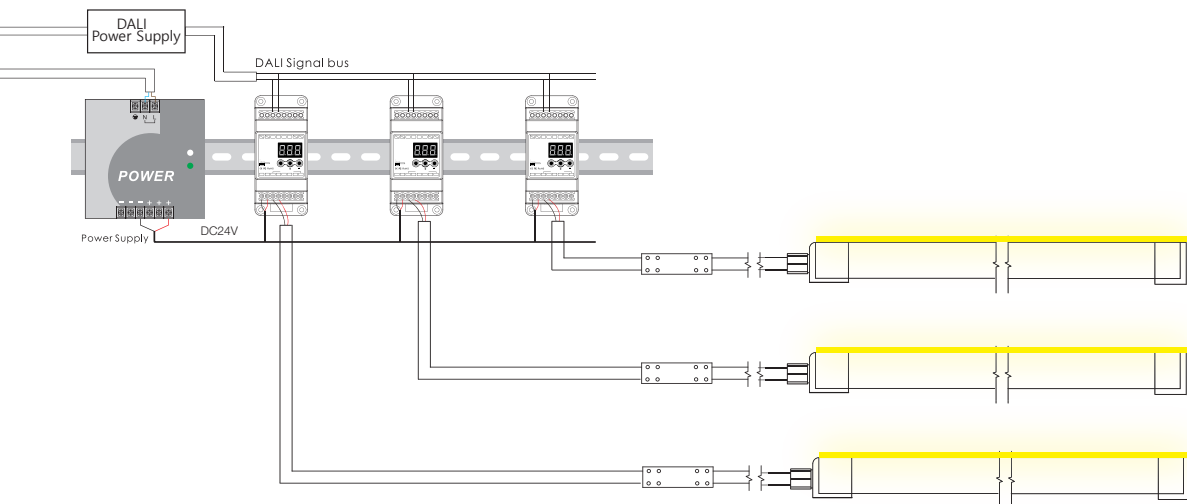

L N