

HELIUM DOWNLIGHT





APPLICATIONS

- Residential
- Offices
- Hallways

FEATURES

- Excellent heat dissipation with a re-engineered heat sink
- Lens based optical system for superior beam control
- Setback light source with black internal ring for low glare
- High quality Bridgelux LED
- Tridonic driver
- Black baffle suitable for task illumination

TECHNICAL DATA

LED WATTS	9 W 15 W
COLOUR TEMP	2700 K, 3000 K, 3500K, 4000 K
LUMENS	700 lm 1200 lm
IP RATING	IP44
BEAM ANGLE	15° 25° 45°
TILTING ANGLE	20° adjustable
CRI	> 90
MOUNTING	Recessed
MATERIALS	Aluminium
OPERATING TEMP	-20°C ~ 40°C
INSULATION CONTACT RATING	IC-4
SERVICE LIFE	L90 B10 = 50.000 hrs
DIMMING	Non-dim DALI dim Phase Cut Bluetooth dim
DIMENSIONS	ø 70 mm x 84 mm
WARRANTY	5 Years
CUTOUT	ø 75 mm
TRIM FINISH	 White  Black  Grey <i>Custom colours available. Black baffle as standard.</i>

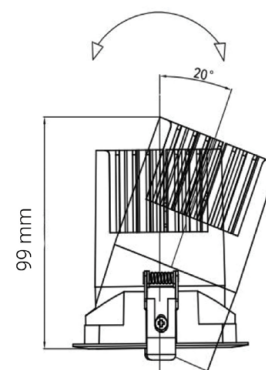
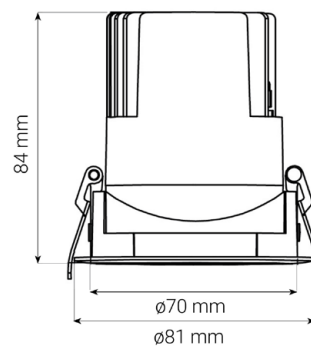

HELIUM DOWNLIGHT



LUMEN SELECTION

HELD					
POWER	CCT	BEAM ANGLE	FINISH	DIMMING	
09 - 9W	27 - 2700K	45	WH	PD - Phase Cut	
15 - 15W	30 - 3000K	25	BL	DD - DALI	
	35 - 3500K	15	GR	BT - Bluetooth	
	40 - 4000K				

An example:

HELD	09	40	15	BL	BT
-------------	-----------	-----------	-----------	-----------	-----------

POLAR CURVES

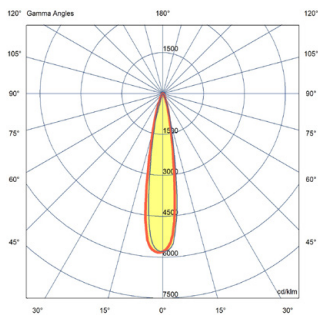

15° beam angle polar curve shown

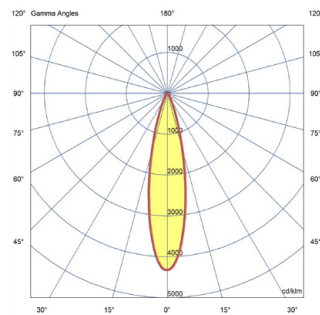

25° beam angle polar curve shown

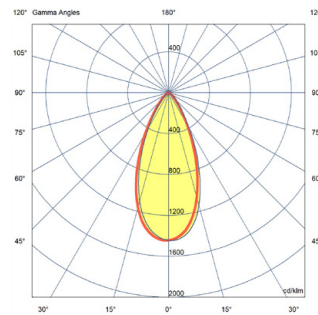

45° beam angle polar curve shown